

Sienna Rattan Wardrobe Assembly Instructions

Pre-assembly Preparation

Please read these instructions fully prior to assembly to familiarise yourself with the various stages of construction. Carefully open all packs supplied and check the contents against the parts and fittings check list.

Do not destroy any of the packaging until you are certain that you have all the necessary parts for the assembly.

This product is **HEAVY**, it should be assembled as near as possible to the point of use.

Take care when lifting to avoid personal injury and (or) damage to the product.

There are small components used in the construction of this furniture as well as plastic foil packaging, these should be kept away from young children whilst assembling.

This product requires a minimum of 2 people to assemble.

Product Safety















All assembly fastenings should always be tightened properly and care should be taken to ensure that no fittings are loose.

Periodically check and ensure that all components are in their proper position, free from damage, and that all connectors are tight.

Product Care

To clean, slightly moisten cloth with water and wipe surfaces. A damp cloth holds dust and prevents damage. repeat with a dry, soft, lint-free cloth.

Do not use abrasives or cleaning products which may contain ammonia or solvents

PARTS		Q'TY
A	 M6	1PCS
B	 $\varnothing 5/16" * 30\text{mm}$	28PCS
B1	 $\varnothing 5/16" * 70\text{mm}$	4PCS
D	 $\varnothing 4 * 16\text{mm}$	4PCS
E		2PCS
F		1PCS
G		1PCS
H		2PCS
I		1PCS
J		1PCS
K		1PCS
L		1PCS
M		4PCS
N		1PCS

1

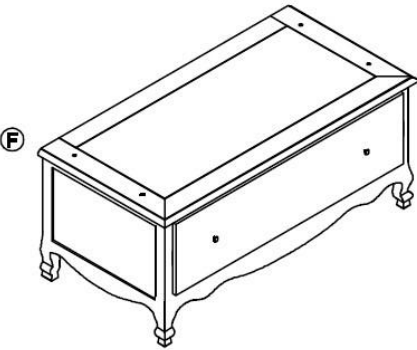

2

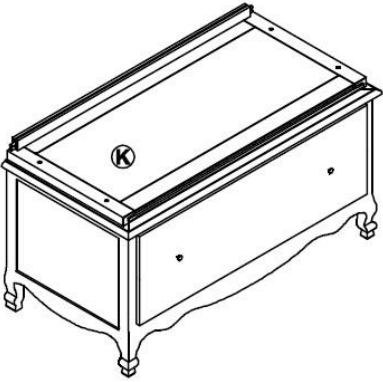

3

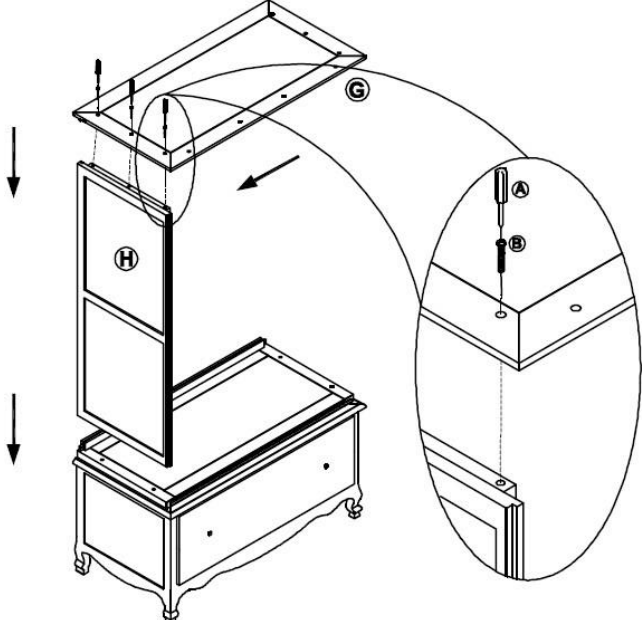

4

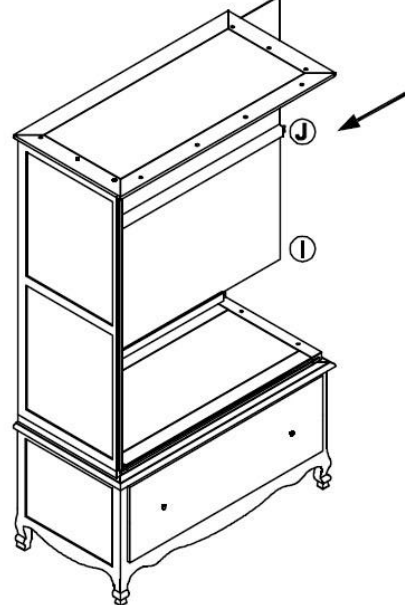

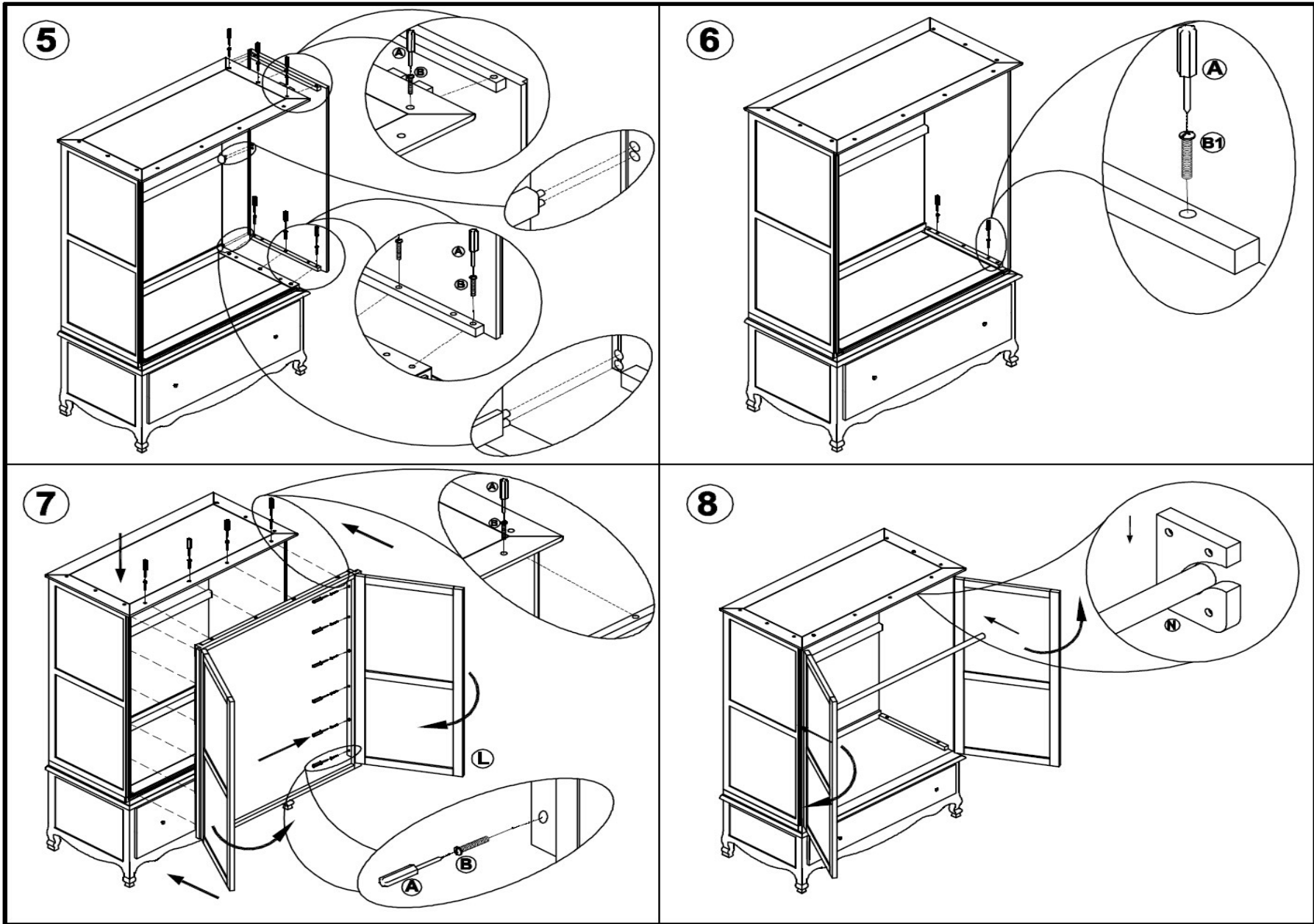

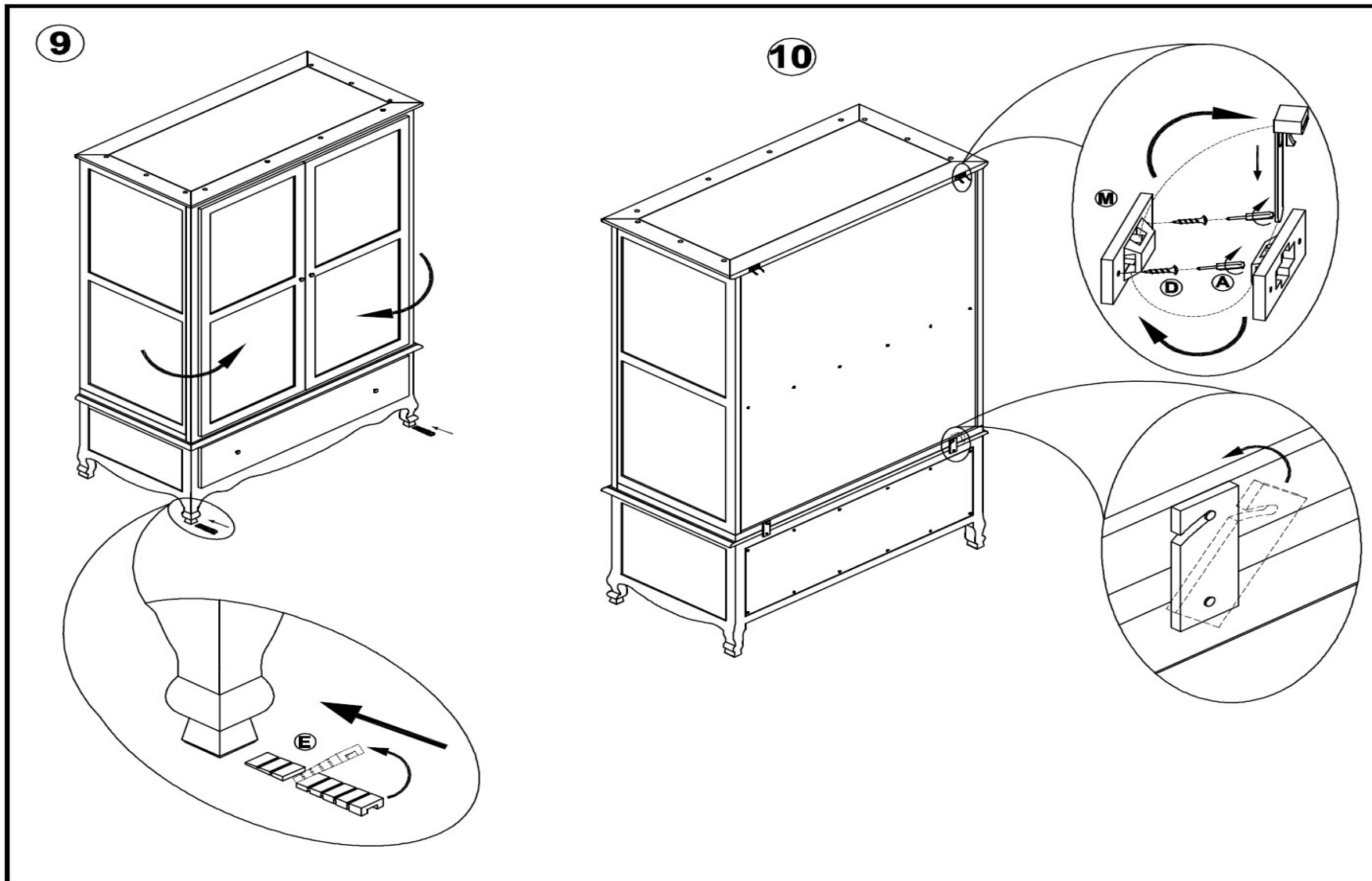

NOTE: IF THE UNIT IS NOT LEVEL, PLACE A LEVELER UNDERNEATH ONE FOOT UNTIL THE UNIT IS LEVEL. BREAK OFF ANYPROTRUDING SEGMENTS

Note: Different wall materials require different types of fixing devices. Use fixing devices suitable for the walls in your home (not included). If you are uncertain about what type of screw or fitting to use, please contact your hardware store.